



# SYST 101: Intro to Systems

## Lecture 18

Mar. 27, 2003

C. Wells, SEOR Dept.



# Announcements

- Remaining Semester Schedule
  - Apr 1, 3                    lecture 19, 20
  - Apr 8, 10                Project 2 laboratory testing
  - Apr 15, 17              lecture 23, 24
  - Apr 22, 24              Project 2 demos and oral presentations
  - Apr 29, May 1        Review for final
  - May 2                    SYST 490/495 presentations
  - May 13                 Final Exam 10:30 – 1:15



# Announcements cont.

- Central Module lab open most evenings.
  - There are almost always graduate students there.
  - Front door should be open till 9 pm.
  - Course is set up halfway.
  - Arrangements can be made for weekends.
    - But contact me or Ning during the week.



# Agenda

- Pop Quiz 2
- Multiple viewpoints
- System trades



# Water & Society

- The trend through history has been to focus on getting water to the city, not away from it.
- Problems include
  - Bad hygiene, flooding, pollution



# Utility of Lifecycles

- Had they been good systems engineers....
- Consider the full lifecycle of the system, from a variety of viewpoints
- Take the viewpoint of different participants in the system



# Example

- An Automobile assembly line
- We can take (at least) 2 views:
  - The assembly station
  - The automobile



# Assembly Station View

- Take the view of the assembly station
- Cars come in, you do your work, cars go out...

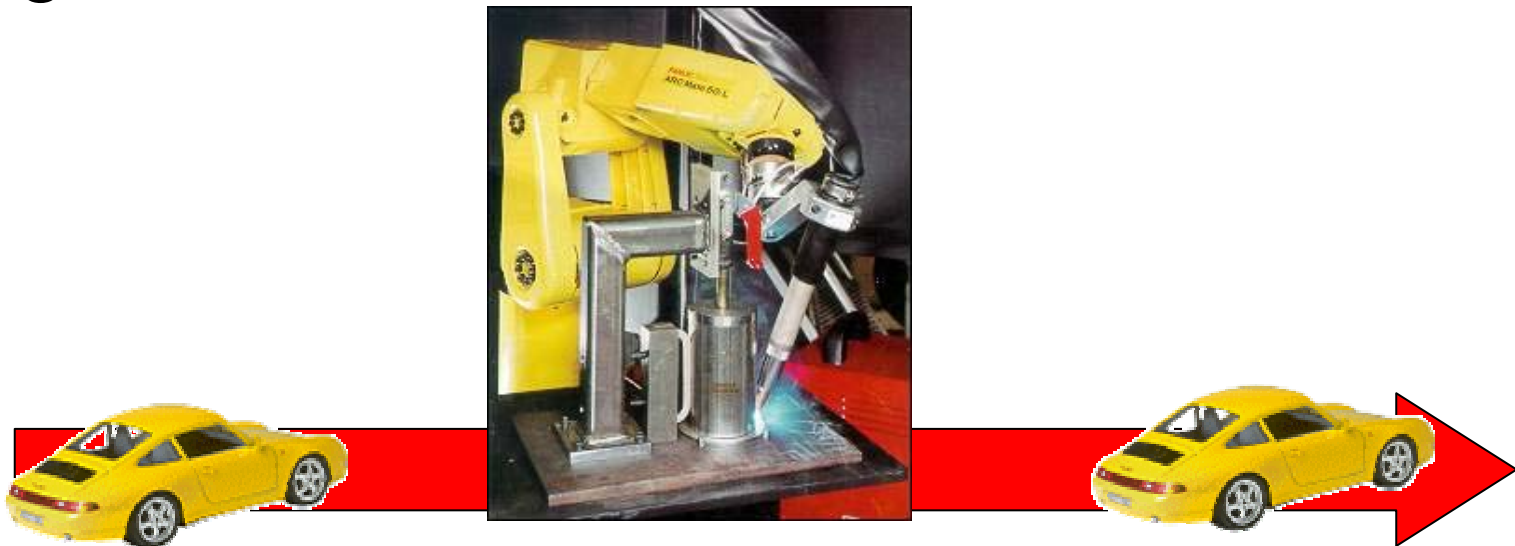





# Automobile View

- (I am a car)
- I move through a series of stations, each one provides me with one of my parts.

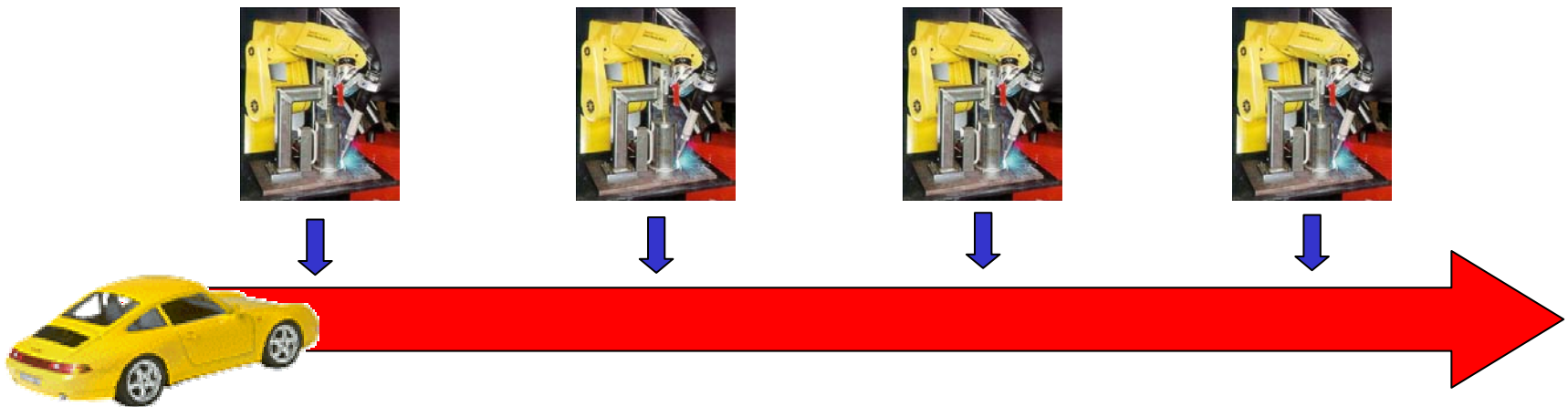



# Alternate Views

- Often taken during the system design process
- Helps assure completeness
- In software, often associated with the object-oriented paradigm.
  - “Active” versus “passive” objects



# Castles of the Middle Ages

- Castles of Europe often were surrounded by moats
- Classic drawbridge provided security
- But the moat served a crucial everyday purpose



# Bathrooms in the Castles

- Cross sectional view...

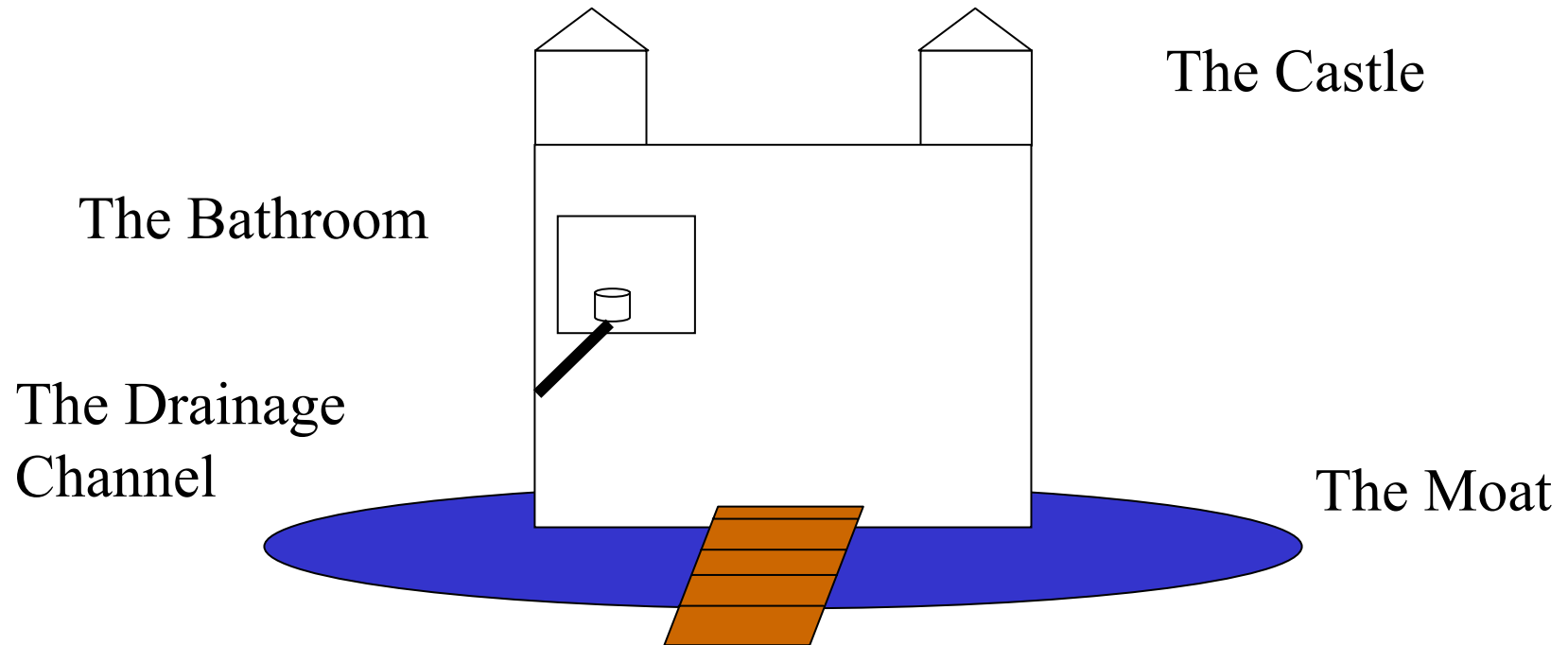



# Operational Concept

- Bring buckets of water up to bathroom.
- After bathroom use, pour water down toilet.
- Sewage washed down channel, drools down outside wall.
- Rain washes walls off into moat.
- Water flow through moat prevents stagnation and unpleasant odors.



# Roman Aqueducts

- The Romans spend an amazing amount of time and effort to get water to Rome
- Very little effort in getting wastewater away from Rome....



# The Waterfall Process

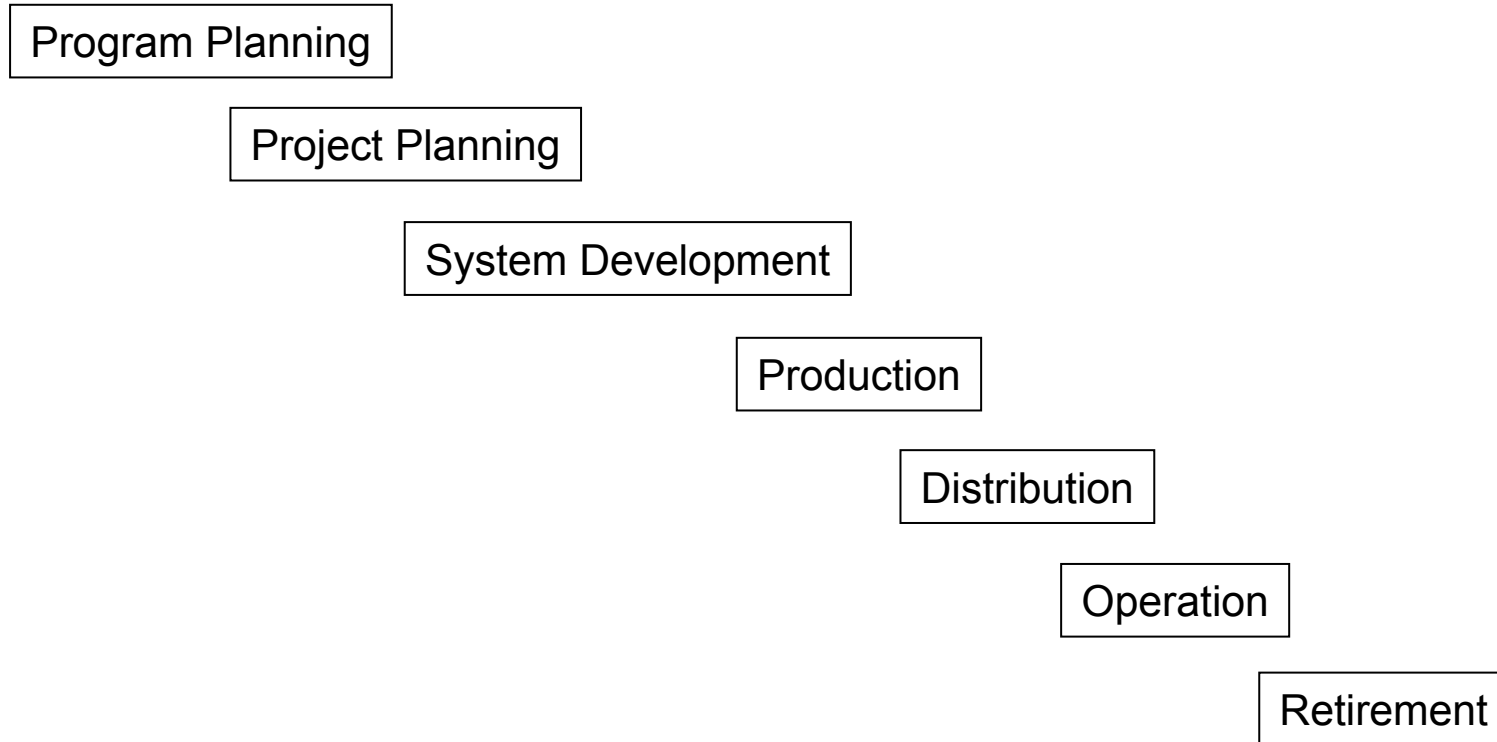



# Example Re-Visited

- Examine the cycle from the *water's* point of view

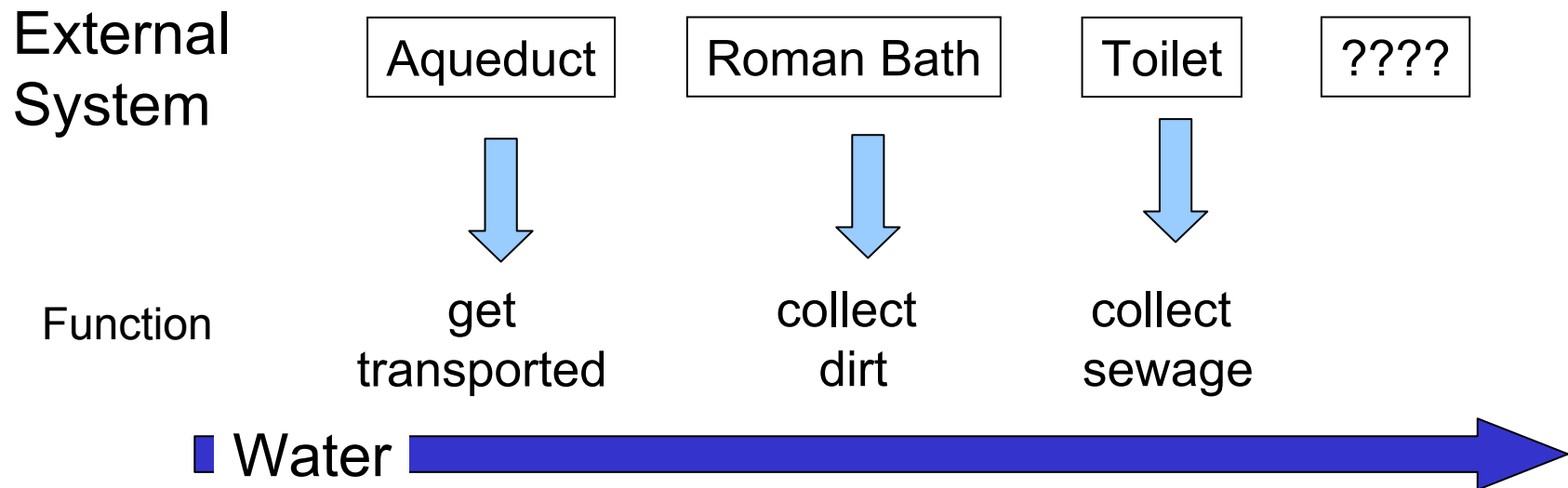

- So, where does the water go after that?





# *Retirement Phase*

- Same goes for hazardous materials, such as solvents, fuels, etc.
- Even if you're engineering the engine, someone on the team should take the viewpoint of the various solvents, fuels, lubricants, and consider their lifecycles as well.



# Personal Computers

- They contain lots of different pollutants, which cause serious problems when they enter the environment
  - Lead, silver, mercury.
  - PCBs and diphenyls when wire & insulation are burned.



# PC Disposal

- Where do obsolete personal computers go?
  - To companies that scrap them
- Where are these companies?
  - Currently, mainly in countries that do not have environmental protection laws, thus allowing them to operate much cheaper (and dirtier)
    - Causing significant pollution in those areas
- Most European countries prohibit the shipping of salvage PCs out to such companies -- the United States does not (yet)



# Consider the Retirement Phase

- Nuclear Power Plant Waste
- Building Dams on Rivers
- Spacecraft & Satellites



# Network Calculations

- A set of water supply or sewage pipes in a city can be considered a network
- (Almost) any combination of nodes and arcs can be considered a network

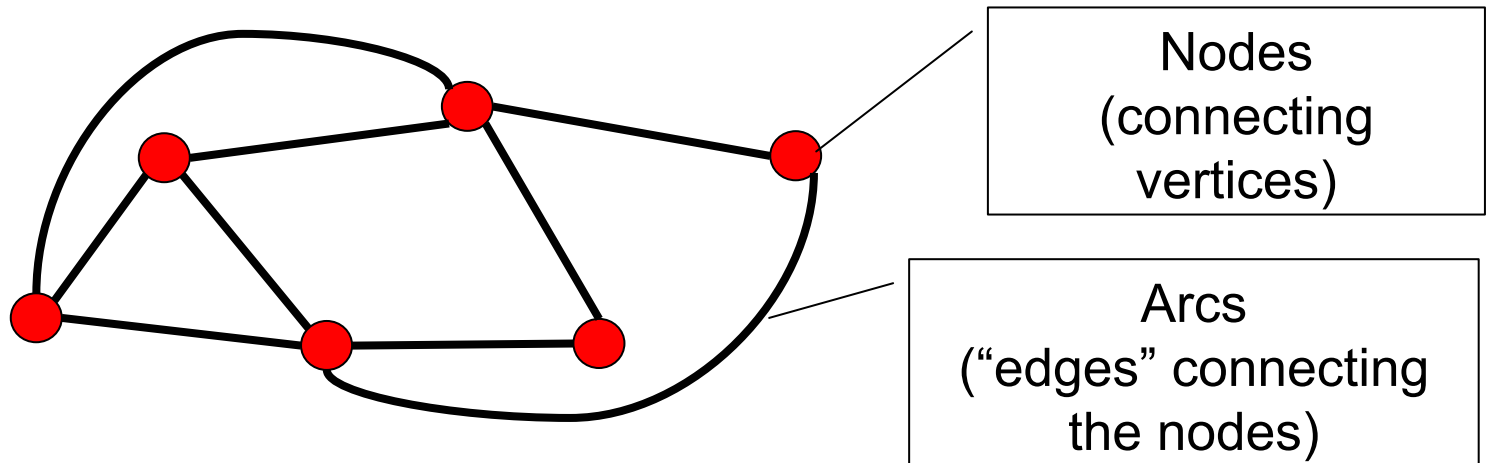



# “What Goes In, Must Come Out”

- In electrical engineering, it's known as Kirchoff's Current Law:
  - The sum of the flows entering a node must be equal to the sum of the flows exiting the node.

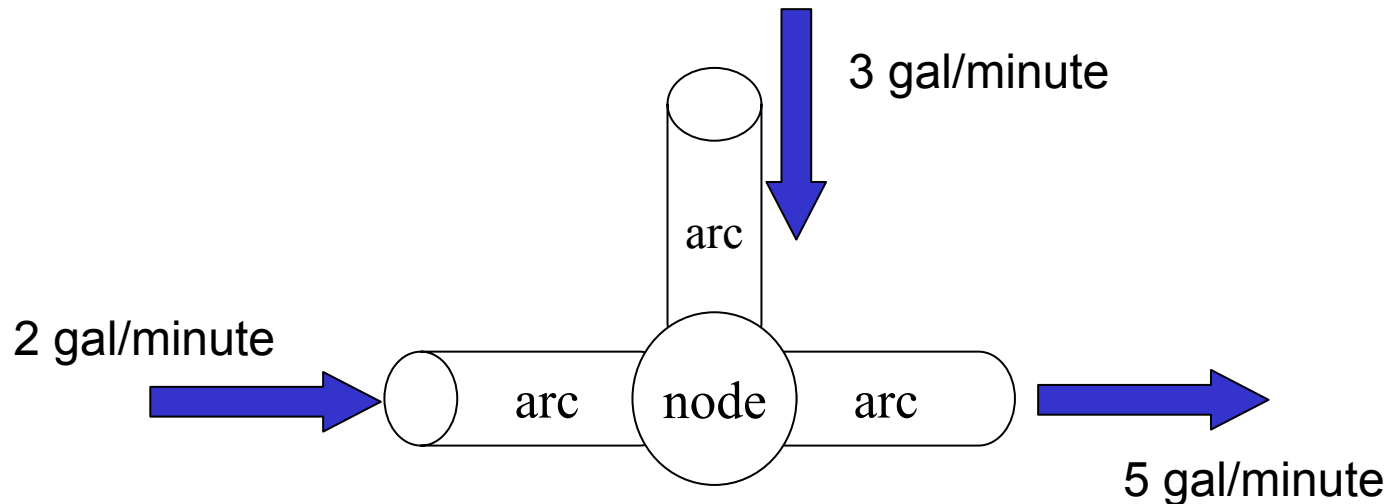



# Network Flow Calculations

- Now can be expressed as sets of related equations, and solved using the “Solver” add-in in Excel
- Linear Equations/Matrix Algebra - MATH 203
- SYST 201, 202, 302 - modeling and optimization



# Assignments

- Reading
  - Petroski, Engineer is Human  
Chapters 9
    - “Safety in Numbers”
- Homework
  - none